

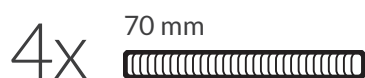

scandicsofa™

MIKI

INSTRUKCJA MONTAŻU



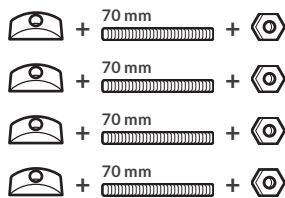
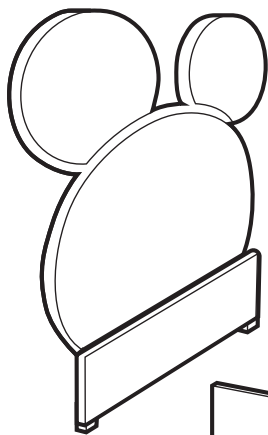

1 | Połącz ze sobą elementy oskrzyni: przedni oraz boczne. Zamontuj nóżki i śruby na przedniej części oskrzyni oraz na wezglowiu.

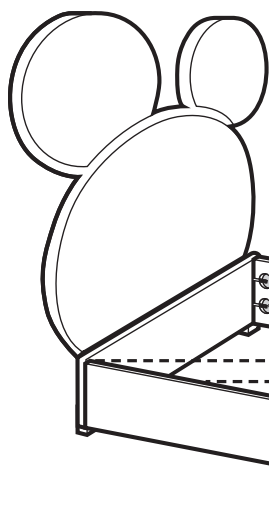
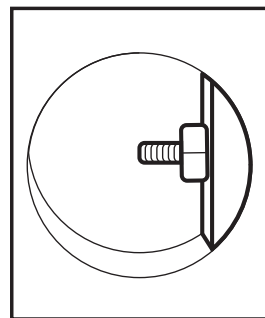
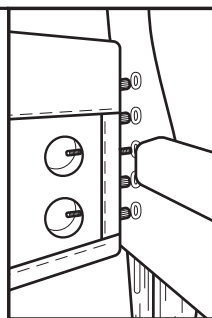
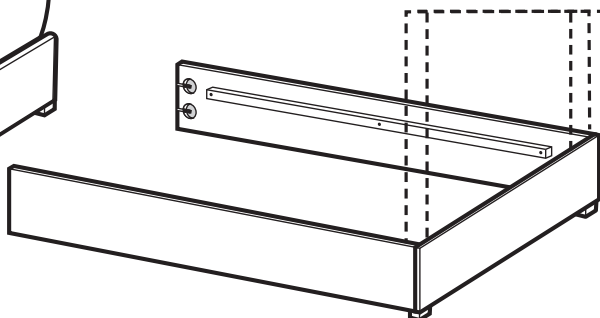

2 | Połącz tylną część oskrzyni z wezglowiem, użyj podkładki oraz śrub 150 mm.

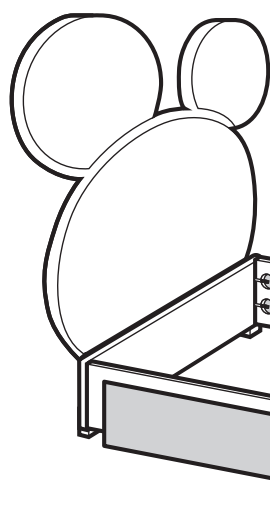
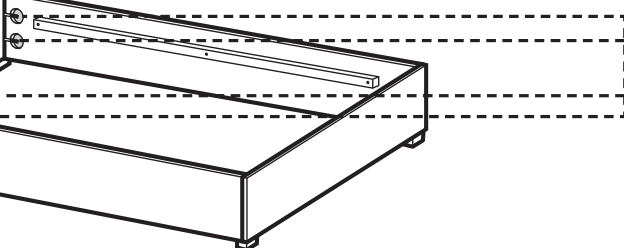
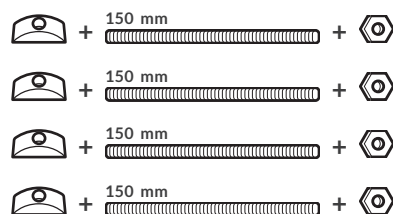

3 | Do złożonej ramy z wezglowiem, przypnij tkaninę. Rzepy do jej przypięcia znajdują się na wewnętrznej stronie ramy. Staraj się równo naciągnąć tkaninę.

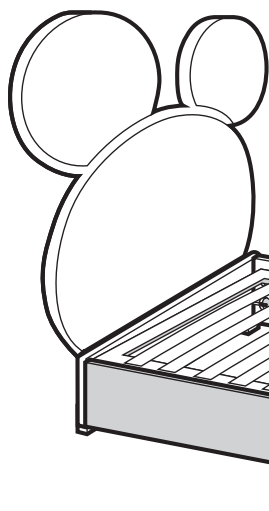

4 | Zamontuj drabinki. Gotowe!